

# Crimp 01 : Soldered contact

## COMPONENTS

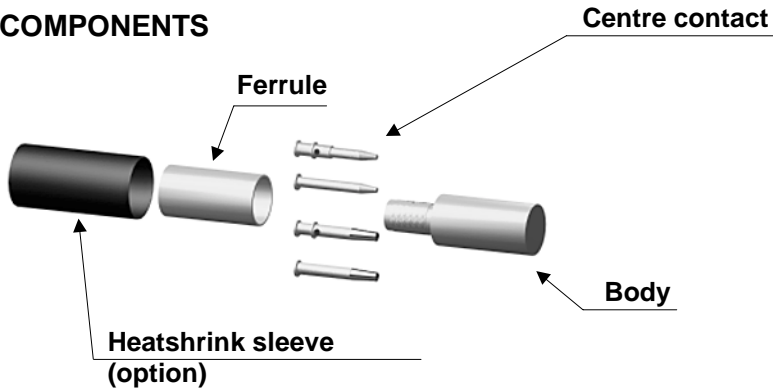

## STRIPPING DIMENSIONS

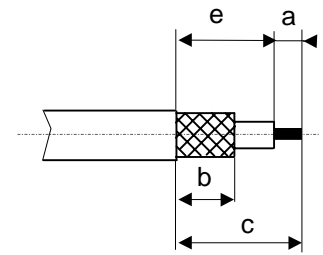

1

Slide the heatshrink sleeve onto the cable (Option).  
Slide the ferrule onto the cable.  
Strip the cable.

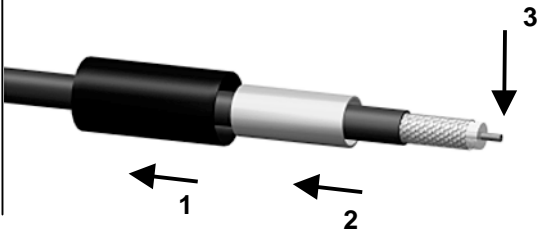

4

Slide the cable into the body until it bottoms against the insulator.

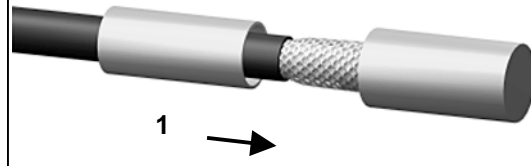

2

Slide the centre contact on until it bottoms against the cable dielectric.  
Solder the centre contact.  
Clean solder area.

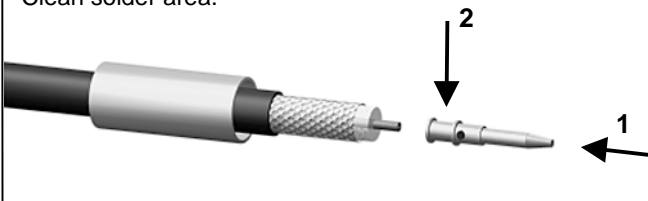

5

Slide the ferrule over the braid.  
Crimp the ferrule with crimping tool ( see connector TDS ).

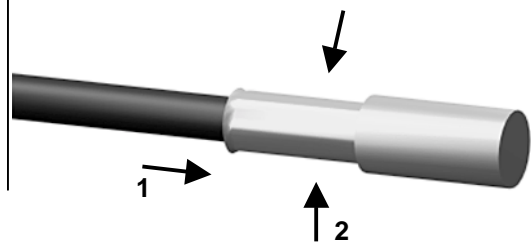

3

Fan the braid.

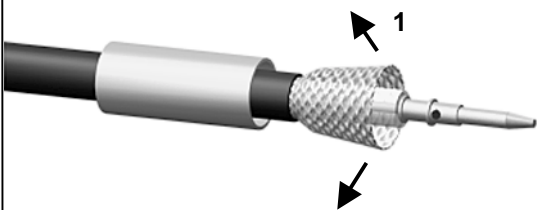

6

Cut the excess of braid if necessary.  
Slide the sleeve over the ferrule and heatshrink it in place (Option).

